

- ★ 100% EAS Guaranteed
- ★ Green Device Available
- ★ Super Low Gate Charge
- ★ Excellent CdV/dt effect decline
- ★ Advanced high cell density Trench technology



Product Summary

BVDSS	RDSON	ID
-40V	25mΩ	-30A

Description

The XXW40P30 is the high cell density trenched P-ch MOSFETs, which provide excellent RDSON and gate charge for most of the synchronous buck converter applications.

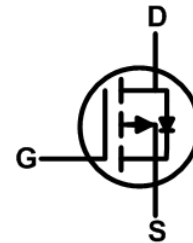
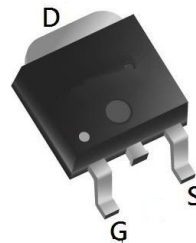
The XXW40P30 meet the RoHS and Green Product requirement 100% EAS guaranteed with full function reliability approved.

TO252 Pin Configuration

Absolute Maximum Ratings

Symbol	Parameter	Rating	Units
V_{DS}	Drain-Source Voltage	-40	V
V_{GS}	Gate-Source Voltage	± 20	V
$I_D@T_C=25^\circ C$	Continuous Drain Current, $-V_{GS} @ -10V^1$	-30	A
$I_D@T_C=100^\circ C$	Continuous Drain Current, $-V_{GS} @ -10V^1$	-25	A
I_{DM}	Pulsed Drain Current ²	-60	A
EAS	Single Pulse Avalanche Energy ³	40.9	mJ
I_{AS}	Avalanche Current	-30.0	A
$P_D@T_C=25^\circ C$	Total Power Dissipation ⁴	35	W
T_{STG}	Storage Temperature Range	-55 to 150	$^\circ C$
T_J	Operating Junction Temperature Range	-55 to 150	$^\circ C$

Thermal Data

Symbol	Parameter	Typ.	Max.	Unit
$R_{\theta JA}$	Thermal Resistance Junction-Ambient ¹	---	62	$^\circ C/W$
$R_{\theta JC}$	Thermal Resistance Junction-Case ¹	---	3.6	$^\circ C/W$

Electrical Characteristics (T_J=25 °C, unless otherwise noted)

Symbol	Parameter	Conditions	Min.	Typ.	Max.	Unit
BV _{DSS}	Drain-Source Breakdown Voltage	V _{GS} =0V, I _D =-250uA	-40	---	---	V
ΔBV _{DSS} /ΔT _J	BV _{DSS} Temperature Coefficient	Reference to 25°C, I _D =-1mA	---	-0.02	---	V/°C
R _{DS(ON)}	Static Drain-Source On-Resistance ²	V _{GS} =-10V, I _D =-8A	---	25	32	mΩ
		V _{GS} =-4.5V, I _D =-4A	---	32	46	
V _{GS(th)}	Gate Threshold Voltage	V _{GS} =V _{DS} , I _D =-250uA	-1.0	---	-2.5	V
ΔV _{GS(th)}	V _{GS(th)} Temperature Coefficient		---	3.72	---	V/°C
I _{DSS}	Drain-Source Leakage Current	V _{DS} =-32V, V _{GS} =0V, T _J =25°C	---	---	1	uA
		V _{DS} =-32V, V _{GS} =0V, T _J =55°C	---	---	5	
I _{GSS}	Gate-Source Leakage Current	V _{GS} =±20V, V _{DS} =0V	---	---	±100	nA
g _{fs}	Forward Transconductance	V _{DS} =-5V, I _D =-8A	---	10.7	---	S
Q _g	Total Gate Charge (-4.5V)	V _{DS} =-15V, V _{GS} =-4.5V, I _D =-1A	---	11.5	---	nC
Q _{gs}	Gate-Source Charge		---	3.5	---	
Q _{gd}	Gate-Drain Charge		---	3.3	---	
T _{d(on)}	Turn-On Delay Time	V _{DD} =-15V, V _{GS} =-10V, R _G =3.3Ω, I _D =-1A	---	22	---	ns
T _r	Rise Time		---	15.7	---	
T _{d(off)}	Turn-Off Delay Time		---	59	---	
T _f	Fall Time		---	5.5	---	
C _{iss}	Input Capacitance	V _{DS} =-15V, V _{GS} =0V, f=1MHz	---	1415	---	pF
C _{oss}	Output Capacitance		---	134	---	
C _{riss}	Reverse Transfer Capacitance		---	102	---	

Diode Characteristics

Symbol	Parameter	Conditions	Min.	Typ.	Max.	Unit
I _S	Continuous Source Current ^{1,5}	V _G =V _D =0V, Force Current	---	---	-30	A
I _{SM}	Pulsed Source Current ^{2,5}		---	---	-60	A
V _{SD}	Diode Forward Voltage ²	V _{GS} =0V, I _S =-1A, T _J =25°C	---	---	-1.2	V

Note :

- The data tested by surface mounted on a 1 inch² FR-4 board with 2OZ copper.
- The data tested by pulsed, pulse width ≤ 300us, duty cycle ≤ 2%
- The EAS data shows Max. rating. The test condition is V_{DD}=-25V, V_{GS}=-10V, L=0.1mH, I_{AS}=-28.6A
- The power dissipation is limited by 150°C junction temperature
- The data is theoretically the same as I_D and I_{DM}, in real applications, should be limited by total power dissipation.

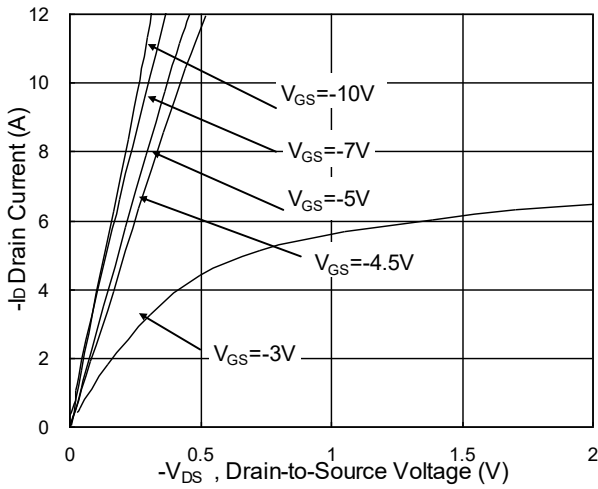
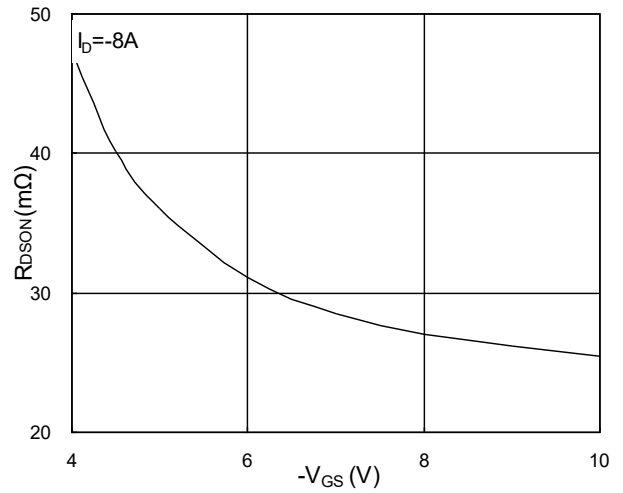
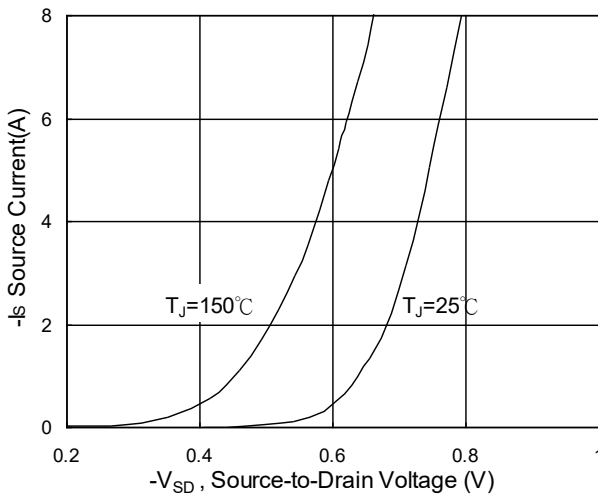
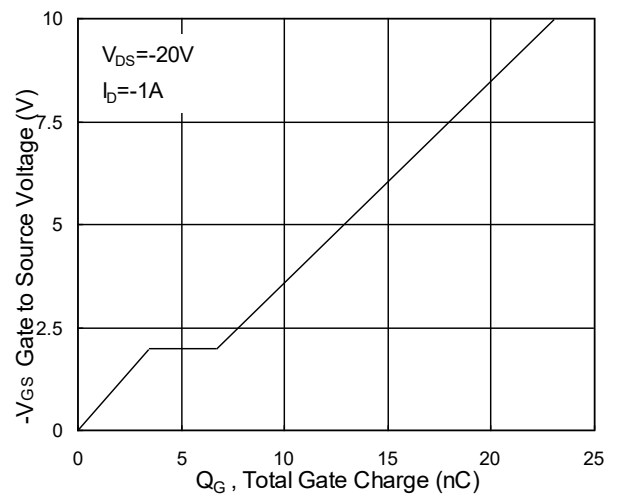
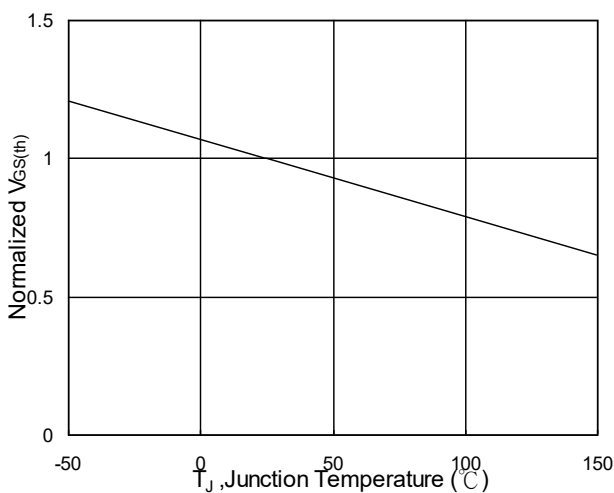
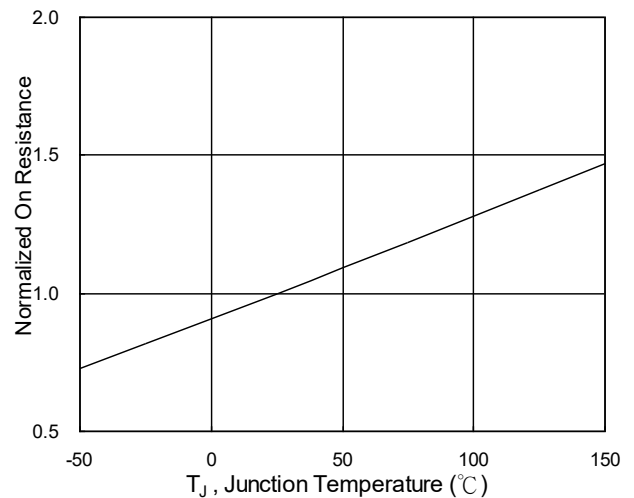
Typical Characteristics

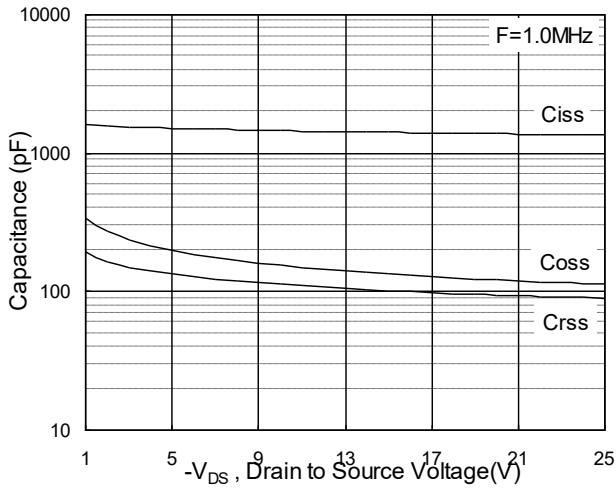
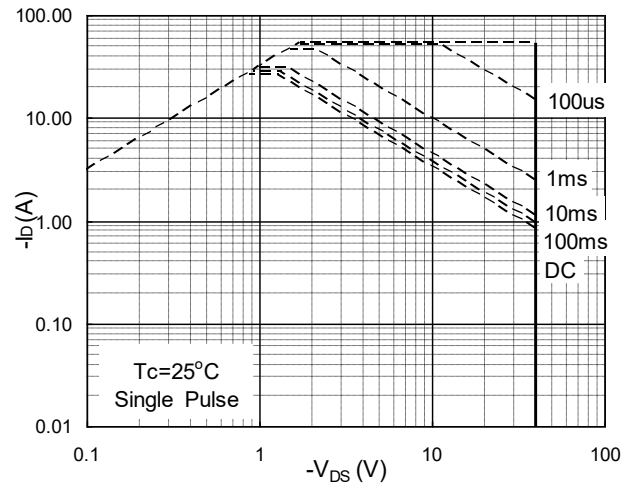
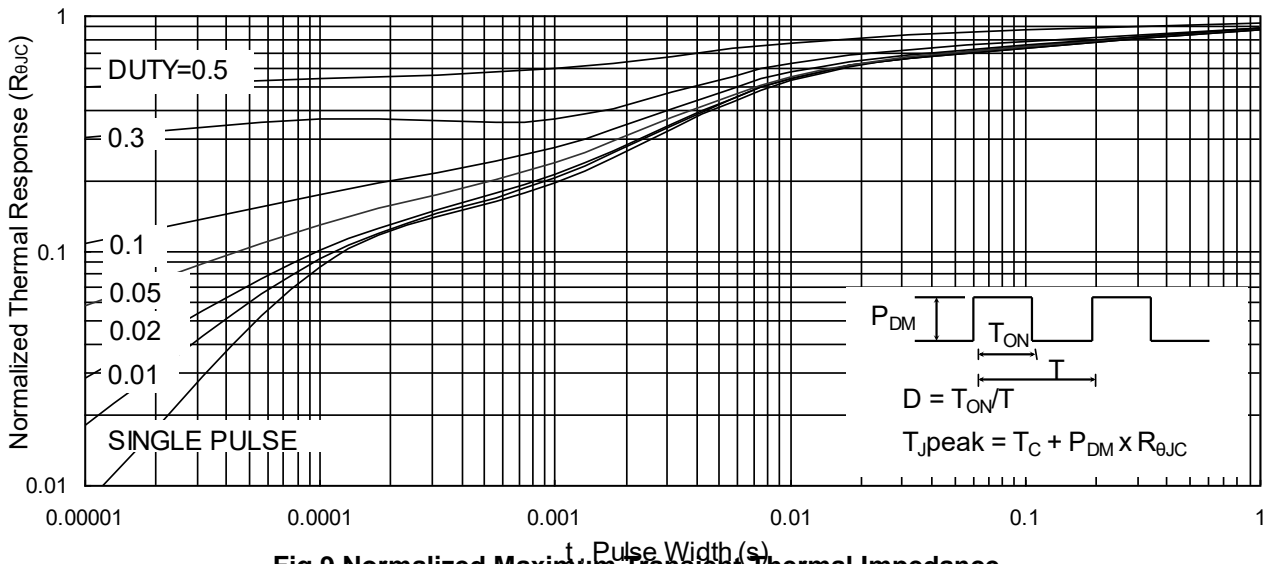
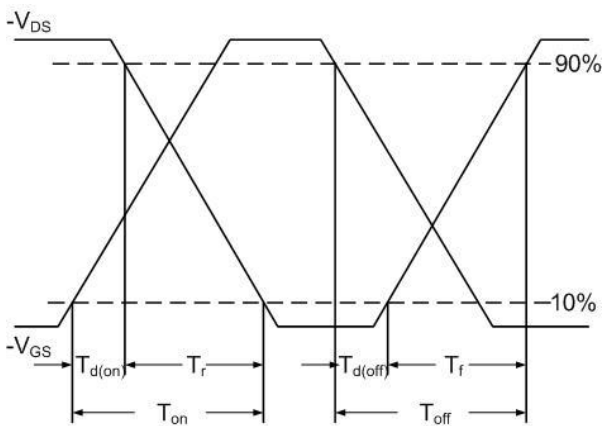
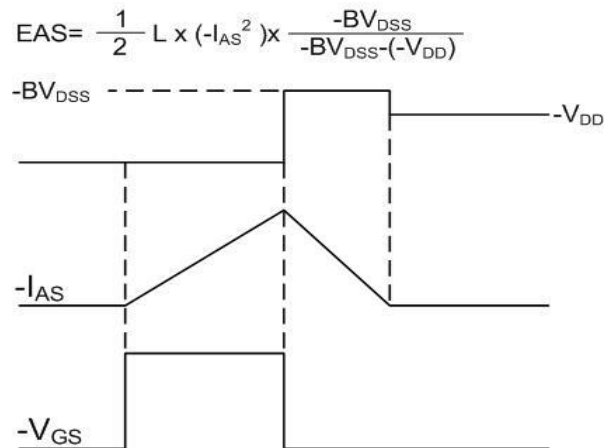
Fig.1 Typical Output Characteristics

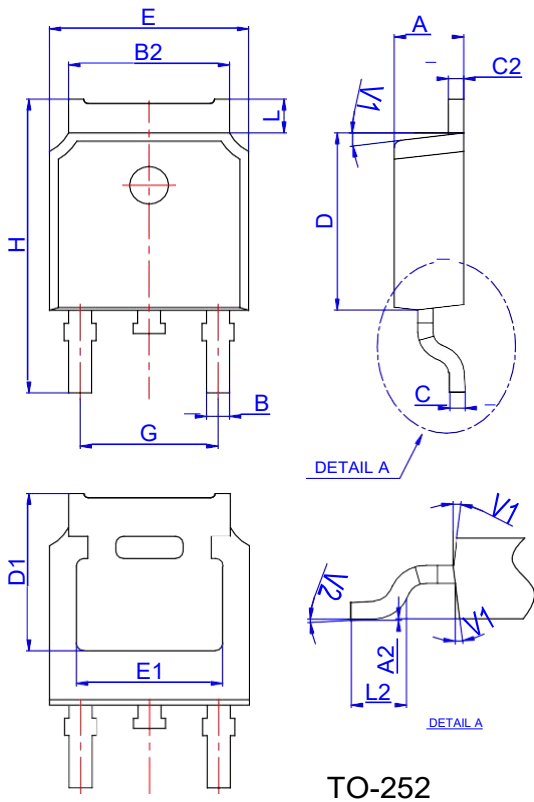
Fig.2 On-Resistance v.s Gate-Source

Fig.3 Forward Characteristics Of Reverse

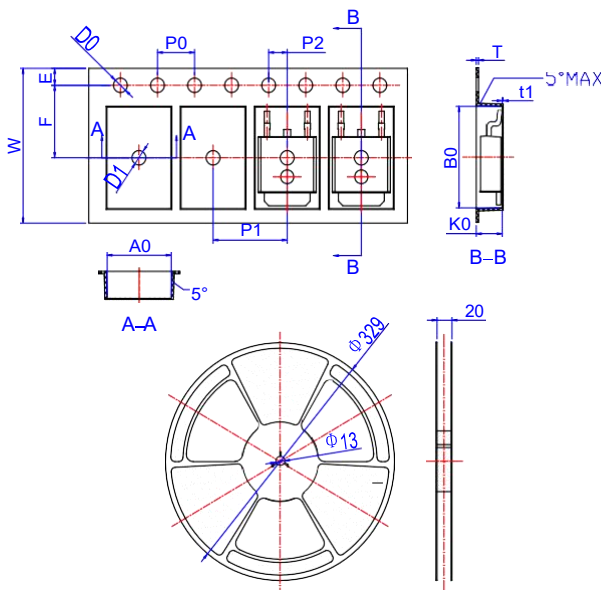
Fig.4 Gate Charge Characteristics

Fig.5 Normalized $V_{GS(th)}$ v.s T_J

Fig.6 Normalized R_{DSon} v.s T_J

Fig.7 Capacitance

Fig.8 Safe Operating Area

Fig.9 Normalized Maximum Transient Thermal Impedance

Fig.10 Switching Time Waveform

Fig.11 Unclamped Inductive Waveform

Package Mechanical Data TO 252

Ref.	Dimensions					
	Millimeters			Inches		
	Min.	Typ.	Max.	Min.	Typ.	Max.
A	2.10		2.50	0.083		0.098
A2	0		0.10	0		0.004
B	0.66		0.86	0.026		0.034
B2	5.18		5.48	0.202		0.216
C	0.40		0.60	0.016		0.024
C2	0.44		0.58	0.017		0.023
D	5.90		6.30	0.232		0.248
D1	5.30REF			0.209REF		
E	6.40		6.80	0.252		0.268
E1	4.63			0.182		
G	4.47		4.67	0.176		0.184
H	9.50		10.70	0.374		0.421
L	1.09		1.21	0.043		0.048
L2	1.35		1.65	0.053		0.065
V1		7°			7°	
V2	0°		6°	0°		6°

Reel Specification-TO-252-4R

Ref.	Dimensions					
	Millimeters			Inches		
	Min.	Typ.	Max.	Min.	Typ.	Max.
W	15.90	16.00	16.10	0.626	0.630	0.634
E	1.65	1.75	1.85	0.065	0.069	0.073
F	7.40	7.50	7.60	0.291	0.295	0.299
D0	1.40	1.50	1.60	0.055	0.059	0.063
D1	1.40	1.50	1.60	0.055	0.059	0.063
P0	3.90	4.00	4.10	0.154	0.157	0.161
P1	7.90	8.00	8.10	0.311	0.315	0.319
P2	1.90	2.00	2.10	0.075	0.079	0.083
A0	6.85	6.90	7.00	0.270	0.271	0.276
B0	10.45	10.50	10.60	0.411	0.413	0.417
K0	2.68	2.78	2.88	0.105	0.109	0.113
T	0.24		0.27	0.009		0.011
t1	0.10			0.004		
10P0	39.80	40.00	40.20	1.567	1.575	1.583