

4.0 A Single-Phase Glass Passivated Bridge Rectifiers

Rectifier Reverse Voltage 50 to 1000V

Features

- Rating to 1000V PRV
- Compact, thin profile package design
- Ideal for SMT manufacturing
- Reliable robust construction
- UL recognized file#E364304

Mechanical Data

- Molding compound meets UL 94 V-0 flammability rating, Halogen-free, RoHS-compliant, and commercial grade
- Polarity indicator: As marked on body
- Weight: 216 mg

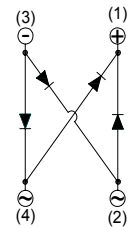
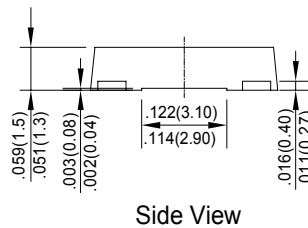
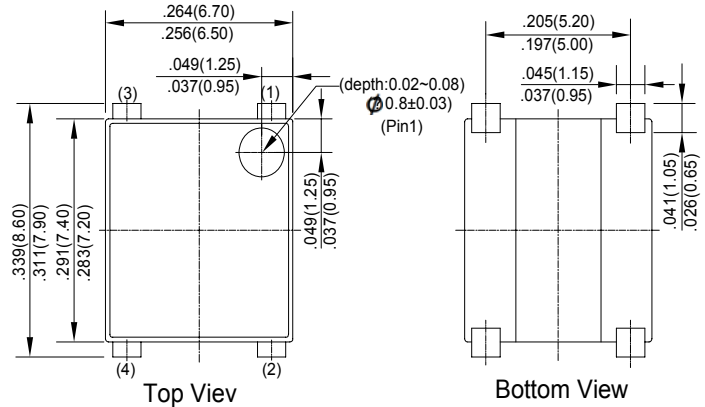

Maximum Ratings & Thermal Characteristics

Dimensions in millimeters (1mm =0.0394")

Rating at 25°C ambient temperature unless otherwise specified, Resistive or Inductive load, 60 Hz.
 For Capacitive load derate current by 20%.

Parameter	Symbol	TMBF 4005	TMBF 401	TMBF 402	TMBF 404	TMBF 406	TMBF 408	TMBF 410	unit
Maximum repetitive peak reverse voltage	VRRM	50	100	200	400	600	800	1000	V
Maximum RMS bridge input voltage	VRMS	35	70	140	280	420	560	700	V
Maximum DC blocking voltage	VDC	50	100	200	400	600	800	1000	V
Maximum average forward rectified output current at TA=40°C	IF(AV)	4.0							A
Peak forward surge current single sine-wave superimposed on rated load (JEDEC Method)	IFSM	110							A
Rating for fusing (t<8.3ms)	I ² t	50.2							A ² sec
Typical thermal resistance per element (1)	ReJA	55							°C / W
Typical junction capacitance per element (2)	C	35.0							pF
Operating junction and storage temperature range	TJ, TSTG	-55 to + 150							°C

Electrical Characteristics

Rating at 25°C ambient temperature unless otherwise specified. Resistive or Inductive load, 60Hz.
 For Capacitive load derate by 20 %.

Parameter	Symbol	TMBF 4005	TMBF 401	TMBF 402	TMBF 404	TMBF 406	TMBF 408	TMBF 410	Unit
Maximum instantaneous forward voltage drop per leg at 2.0A	VF	1.05							V
Maximum DC reverse current at rated DC blocking voltage per element	IR	5 500							μA

Notes: (1) Thermal resistance from Junction to Ambient on P.C.board mounting.
 (2) Measured at 2.0MHz and applied reverse voltage of 4.0 volts.

Rating and Characteristic Curves ($T_A=25^\circ\text{C}$ Unless otherwise noted)

TMBF4005 thru TMBF410

Fig. 1 Derating Curve for Output Rectified Current

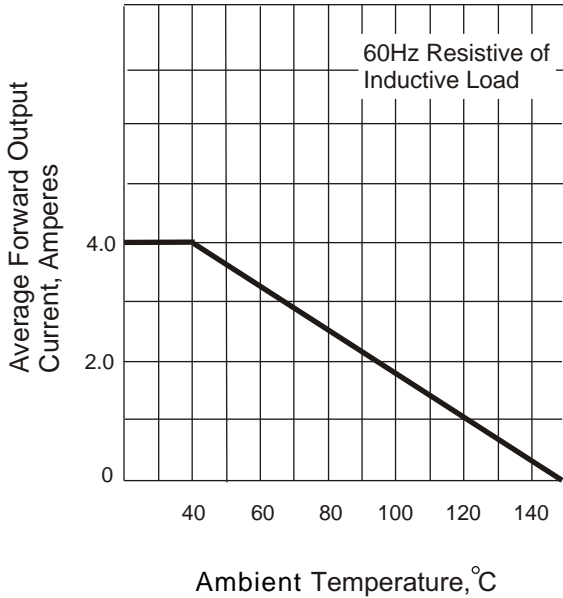

Fig. 2 Maximum Non-repetitive Peak Forward Surge Current

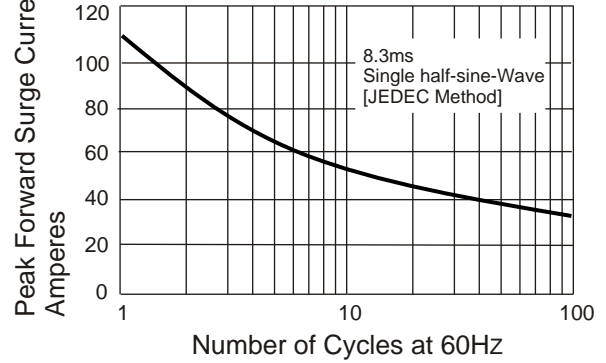

Fig. 3 Typical Instantaneous Forward Characteristics

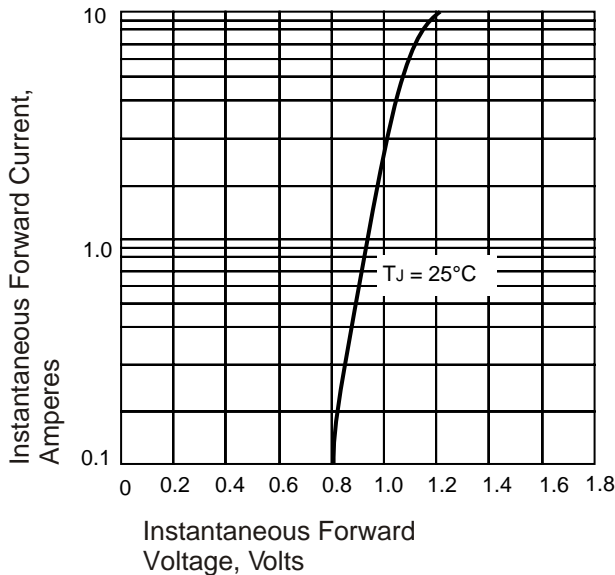

Fig. 4 Typical Revers Characteristics

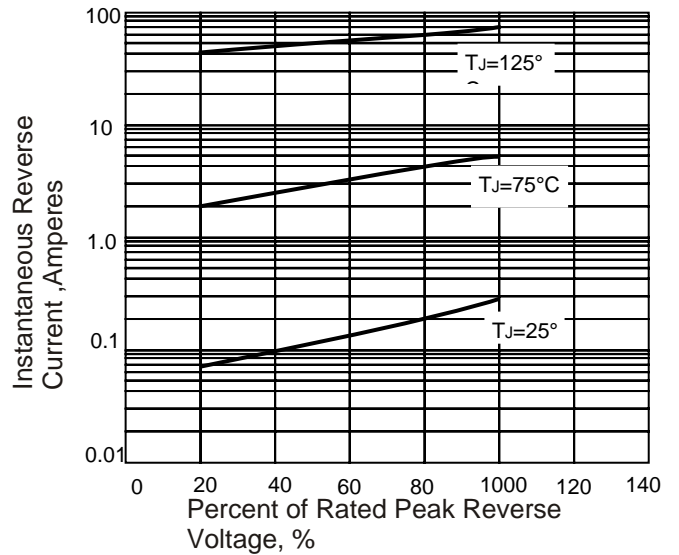

Fig. 5 Typical Junction Capacitance

