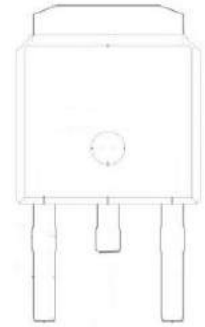
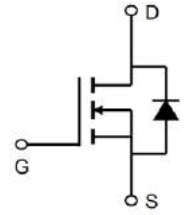

300V N-Channel Enhancement Mode MOSFET
Description

The 5N30D is silicon N-channel Enhanced VDMOSFETs, is obtained by the self-aligned planar Technology which reduce the conduction loss, improve switching performance and enhance the avalanche energy. The transistor can be used in various power switching circuit for system miniaturization and higher efficiency.

General Features

$V_{DS} = 300V, I_D = 5A$

$R_{DS(ON)} < 1.5\Omega @ V_{GS} = 10V$

Application

Uninterruptible Power Supply(UPS)

Power Factor Correction (PFC)

Absolute Maximum Ratings $T_C = 25^\circ C$, unless otherwise noted

Parameter	Symbol	Value	Unit
Drain-Source Voltage ($V_{GS} = 0V$)	V_{DSS}	300	V
Continuous Drain Current	I_D	5	A
Pulsed Drain Current	I_{DM}	20	A
Gate-Source Voltage	V_{GSS}	± 25	V
Single Pulse Avalanche Energy	E_{AS}	50	mJ
Avalanche Current	I_{AR}	3.2	A
Repetitive Avalanche Energy	E_{AR}	1.5	mJ
Power Dissipation ($T_C = 25^\circ C$)	P_D	58.7	W
Operating Junction and Storage Temperature Range	T_J, T_{stg}	-55~+150	$^\circ C$
Thermal Resistance, Junction-to-Case	R_{thJC}	2.13	$^\circ C/W$
Thermal Resistance, Junction-to-Ambient	R_{thJA}	60	

300V N-Channel Enhancement Mode MOSFET
Electrical Characteristics at $T_J=25\text{ }^\circ\text{C}$ unless otherwise specified

Parameter	Symbol	Test Conditions	Min.	Typ.	Max.	Unit
Drain-Source Breakdown Voltage	$V_{(BR)DSS}$	$V_{GS} = 0V, I_D = 250\mu A$	300	--	--	V
Zero Gate Voltage Drain Current	IDSS	$V_{DS} = 300V, V_{GS} = 0V, T_J = 25^\circ C$	--	--	1	μA
		$V_{DS} = 240V, V_{GS} = 0V, T_J = 125^\circ C$	--	--	100	
Gate-Source Leakage	IGSS	$V_{GS} = \pm 25V$	--	--	± 100	nA
Gate-Source Threshold Voltage	VGS(th)	$V_{DS} = V_{GS}, I_D = 250\mu A$	2.2	--	3.2	V
Drain-Source On-Resistance (Note3)	RDS(on)	$V_{GS} = 10V, I_D = 2.5A$	--	1.2	1.5	Ω
Input Capacitance	C_{iss}	$V_{GS} = 0V, V_{DS} = 25V, f = 1.0MHz$	--	291	--	μF
Output Capacitance	C_{oss}		--	43	--	
Reverse Transfer Capacitance	C_{rss}		--	7	--	
Total Gate Charge	Q_g	$V_{DD} = 240V, I_D = 5.0A, V_{GS} = 10V$	--	8.4	--	nC
Gate-Source Charge	Q_{gs}		--	1.2	--	
Gate-Drain Charge	Q_{gd}		--	3.3	--	
Turn-on Delay Time	$t_{d(on)}$	$V_{DD} = 150V, I_D = 5.0A, R_G = 25\ \Omega$	--	20	--	ns
Turn-on Rise Time	t_r		--	50	--	
Turn-off Delay Time	$t_{d(off)}$		--	70	--	
Turn-off Fall Time	t_f		--	53	--	
Continuous Body Diode Current	I_S	$T_C = 25\text{ }^\circ C$	--	--	5	A
Pulsed Diode Forward Current	ISM		--	--	20	
Body Diode Voltage	V_{SD}	$T_J = 25^\circ C, I_{SD} = 5A, V_{GS} = 0V$	--	--	1.4	V
Reverse Recovery Time	t_{rr}	$V_{GS} = 0V, I_S = 5A, di_F/dt = 100A/\mu s$	--	263	--	ns
Reverse Recovery Charge	Q_{rr}		--	1.9	--	μC

Notes

1. Repetitive Rating: Pulse width limited by maximum junction temperature
2. $I_{AS} = 3.2A, V_{DD} = 50V, R_G = 25\ \Omega, \text{Starting } T_J = 25\text{ }^\circ C$
3. Pulse Test: Pulse width $\leq 300\mu s, \text{Duty Cycle } \leq 1\%$

300V N-Channel Enhancement Mode MOSFET
Typical Characteristics $T_J = 25^\circ\text{C}$, unless otherwise noted

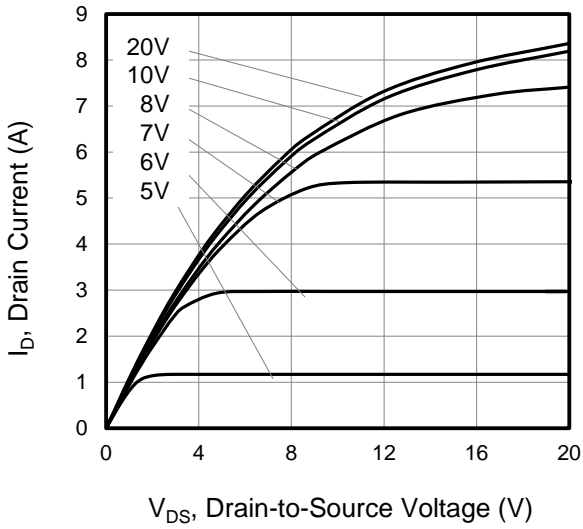
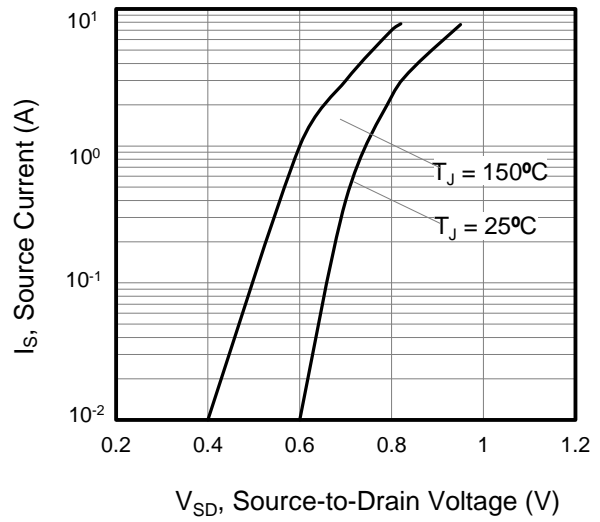
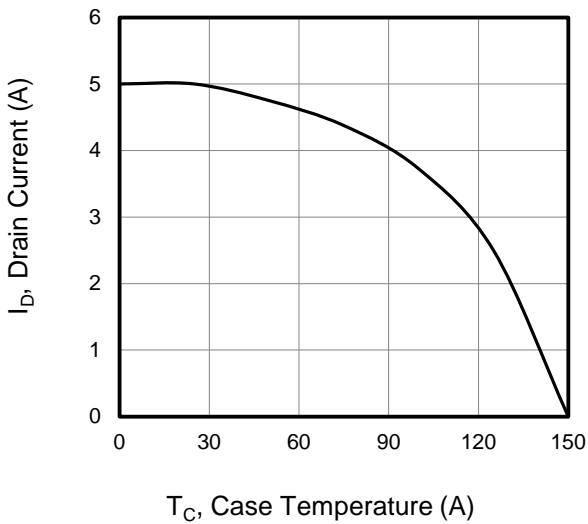
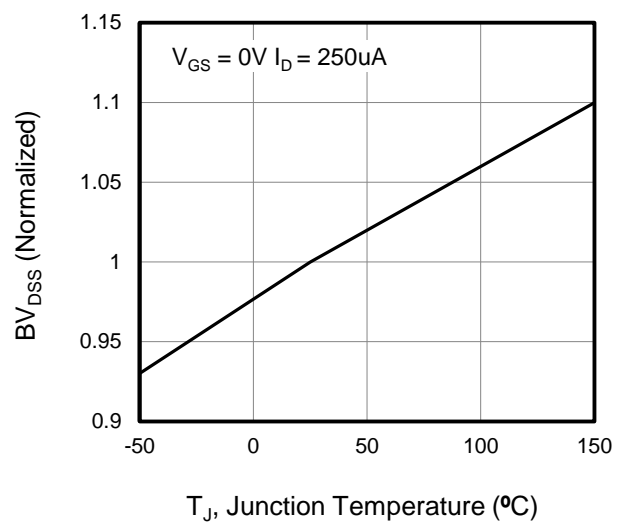
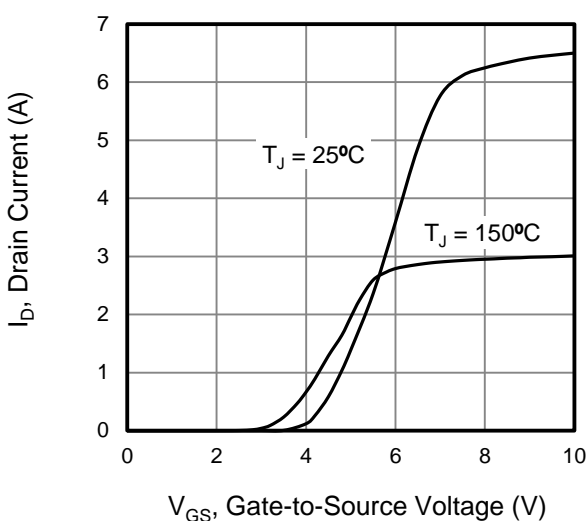
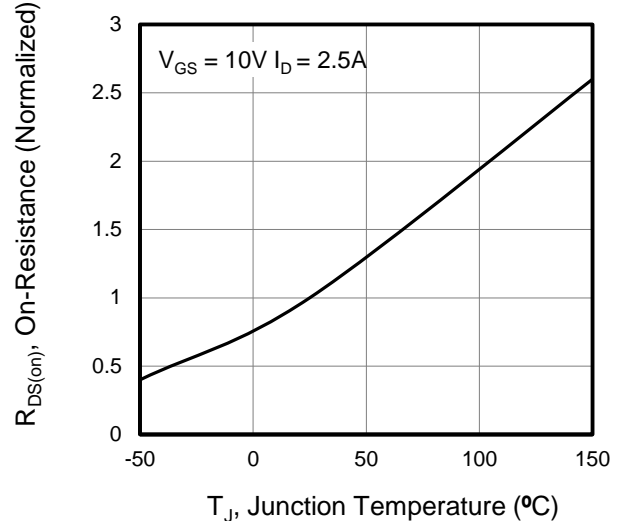
Figure 1. Output Characteristics ($T_J = 25^\circ\text{C}$)

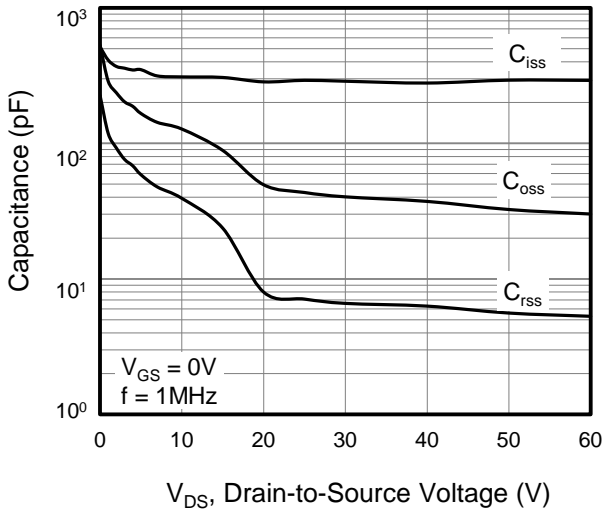
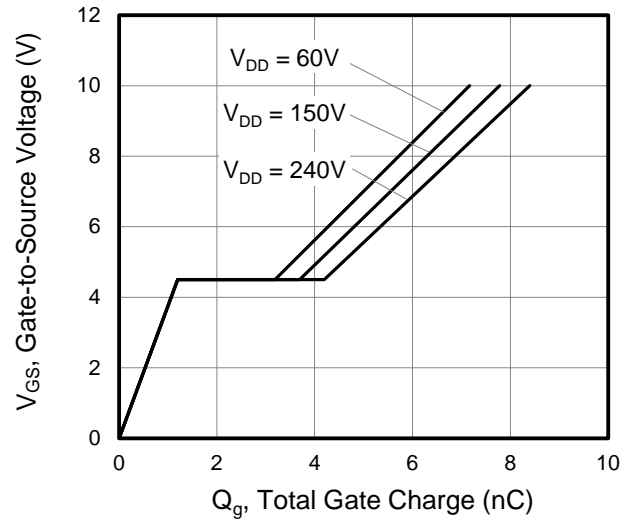
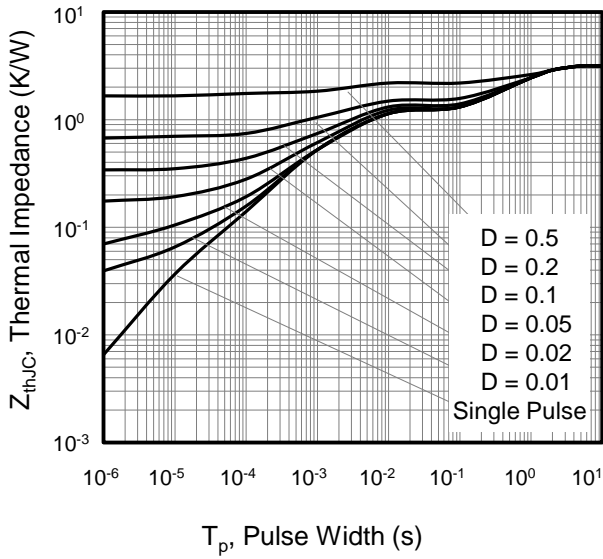
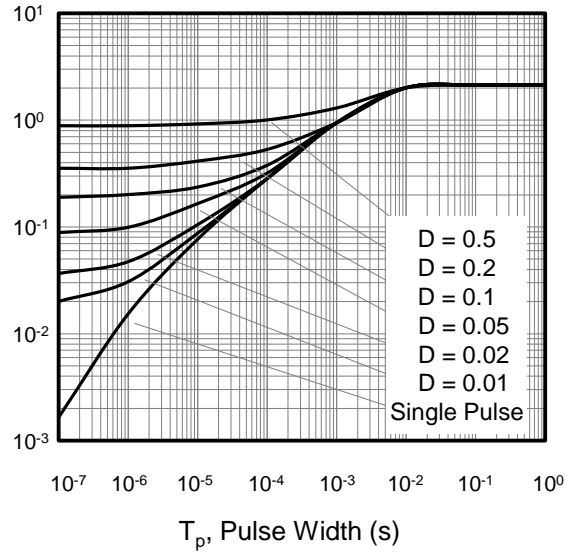
Figure 2. Body Diode Forward Voltage

Figure 3. Drain Current vs. Temperature

Figure 4. BV_{DSS} Variation vs. Temperature

Figure 5. Transfer Characteristics

Figure 6. On-Resistance vs. Temperature

300V N-Channel Enhancement Mode MOSFET
Figure 7. Capacitance

Figure 8. Gate Charge

Figure 9. Transient Thermal Impedance TO-220F

Figure 10. Transient Thermal Impedance TO-251, TO-252

300V N-Channel Enhancement Mode MOSFET

Figure A: Gate Charge Test Circuit and Waveform

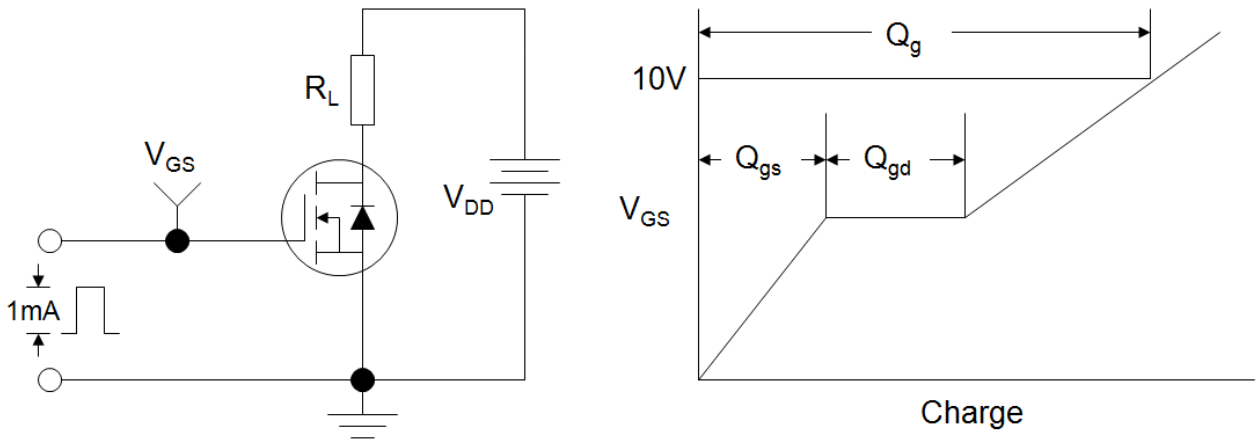

Figure B: Resistive Switching Test Circuit and Waveform

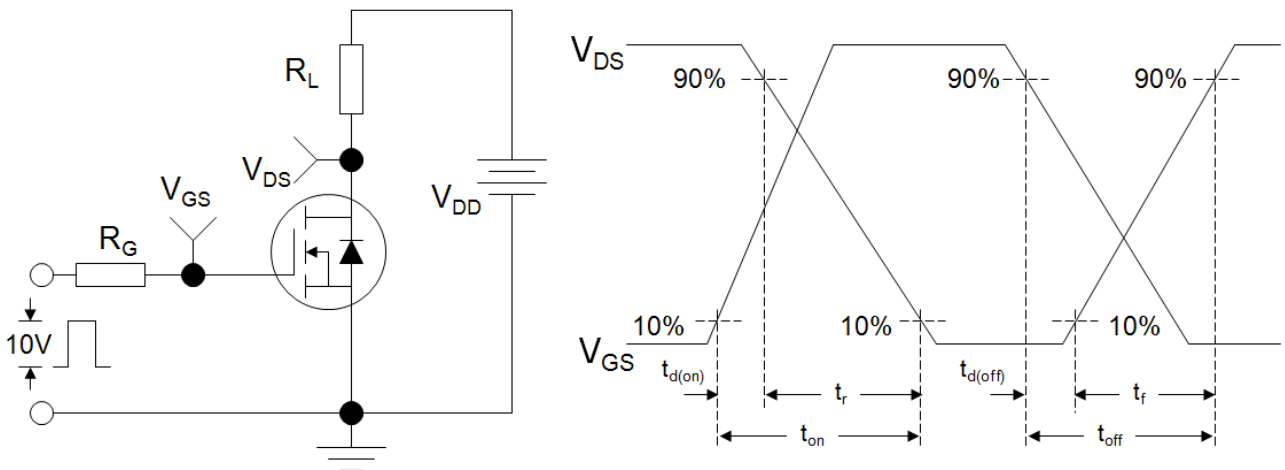
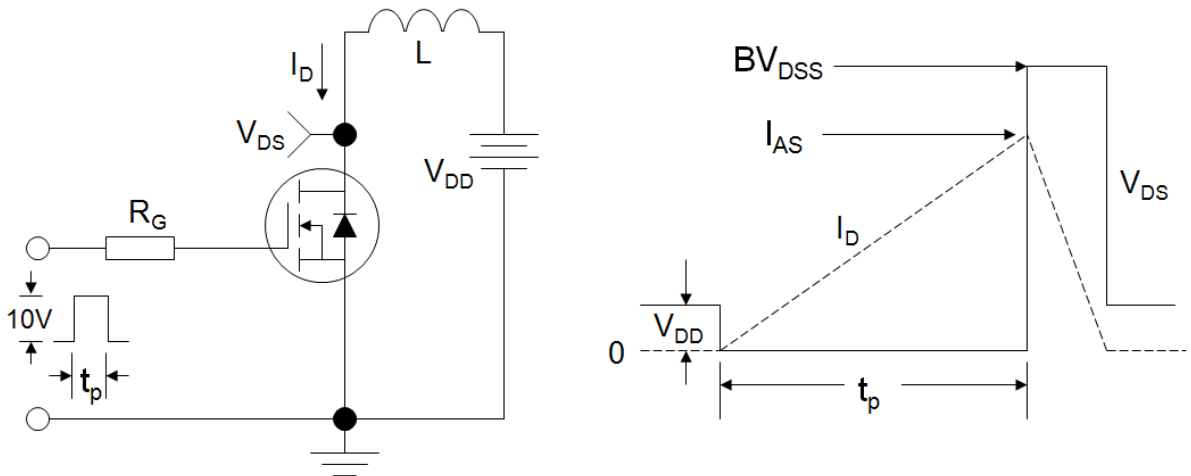
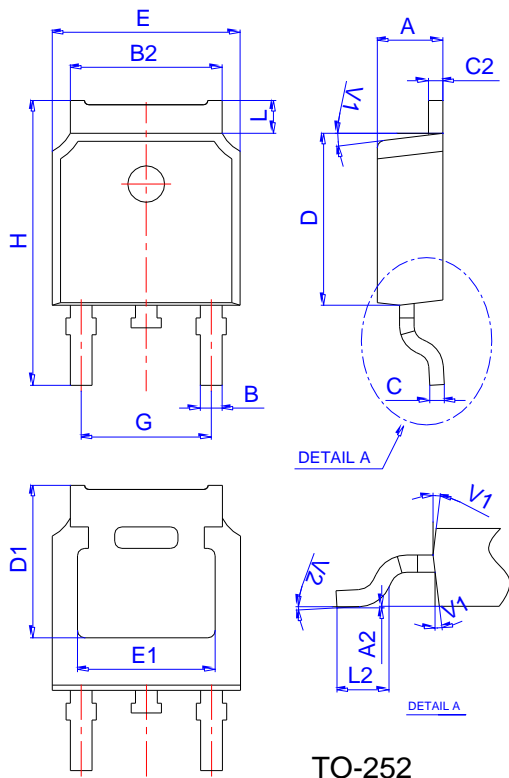
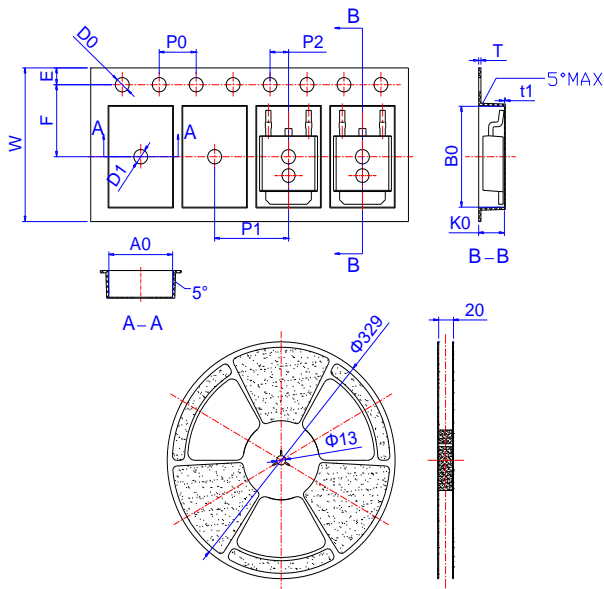

Figure C: Unclamped Inductive Switching Test Circuit and Waveform



300V N-Channel Enhancement Mode MOSFET
Package Mechanical Data

Ref.	Dimensions					
	Millimeters			Inches		
	Min.	Typ.	Max.	Min.	Typ.	Max.
A	2.10		2.50	0.083		0.098
A2	0		0.10	0		0.004
B	0.66		0.86	0.026		0.034
B2	5.18		5.48	0.202		0.216
C	0.40		0.60	0.016		0.024
C2	0.44		0.58	0.017		0.023
D	5.90		6.30	0.232		0.248
D1	5.30REF			0.209REF		
E	6.40		6.80	0.252		0.268
E1	4.63			0.182		
G	4.47		4.67	0.176		0.184
H	9.50		10.70	0.374		0.421
L	1.09		1.21	0.043		0.048
L2	1.35		1.65	0.053		0.065
V1		7°			7°	
V2	0°		6°	0°		6°

Reel Specification-TO-252

Ref.	Dimensions					
	Millimeters			Inches		
	Min.	Typ.	Max.	Min.	Typ.	Max.
W	15.90	16.00	16.10	0.626	0.630	0.634
E	1.65	1.75	1.85	0.065	0.069	0.073
F	7.40	7.50	7.60	0.291	0.295	0.299
D0	1.40	1.50	1.60	0.055	0.059	0.063
D1	1.40	1.50	1.60	0.055	0.059	0.063
P0	3.90	4.00	4.10	0.154	0.157	0.161
P1	7.90	8.00	8.10	0.311	0.315	0.319
P2	1.90	2.00	2.10	0.075	0.079	0.083
A0	6.85	6.90	7.00	0.270	0.271	0.276
B0	10.45	10.50	10.60	0.411	0.413	0.417
K0	2.68	2.78	2.88	0.105	0.109	0.113
T	0.24		0.27	0.009		0.011
t1	0.10			0.004		
10P0	39.80	40.00	40.20	1.567	1.575	1.583