

Surface Mount Superfast Recovery Rectifier
Reverse Voltage – 50 to 600 V
Forward Current –2 A
FEATURES

- For surface mounted applications
- Low profile package
- Glass Passivated Chip Junction
- Superfast reverse recovery time
- Lead free in comply with EU RoHS 2011/65/EU directives

MECHANICAL DATA

- Case: SMAF
- Terminals: Solderable per MIL-STD-750, Method 2026
- Approx. Weight: 27mg 0.00086oz

PINNING

PIN	DESCRIPTION
1	Cathode
2	Anode

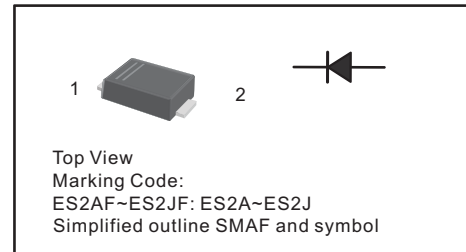
Absolute Maximum Ratings and Characteristics

Ratings at 25 °C ambient temperature unless otherwise specified. Single phase, half wave, 60 Hz, resistive or inductive load.
 For capacitive load, derate current by 20%.

Parameter	Symbols	ES2AF	ES2BF	ES2CF	ES2DF	ES2EF	ES2GF	ES2JF	Units
Maximum Repetitive Peak Reverse Voltage	V_{RRM}	50	100	150	200	300	400	600	V
Maximum RMS voltage	V_{RMS}	35	70	105	140	210	280	420	V
Maximum DC Blocking Voltage	V_{DC}	50	100	150	200	300	400	600	V
Maximum Average Forward Rectified Current at $T_L = 100\text{ }^\circ\text{C}$	$I_{F(AV)}$	2							A
Peak Forward Surge Current 8.3 ms Single Half Sine Wave Superimposed on Rated Load (JEDEC Method)	I_{FSM}	50							A
Maximum Forward Voltage at 2A	V_F	1				1.25		1.7	V
Maximum DC Reverse Current at Rated DC Blocking Voltage $T_a = 25\text{ }^\circ\text{C}$ $T_a = 125\text{ }^\circ\text{C}$	I_R	5 100							μA
Typical Junction Capacitance at $V_R=4\text{V}$, $f=1\text{MHz}$	C_j	60							pF
Maximum Reverse Recovery Time at $I_F=0.5\text{A}$, $I_R=1\text{A}$, $I_{rr}=0.25\text{A}$	t_{rr}	35							ns
Operating and Storage Temperature Range	T_j, T_{stg}	-55 ~ +150							$^\circ\text{C}$

Fig.1 Reverse Recovery Time Characteristic And Test Circuit Diagram

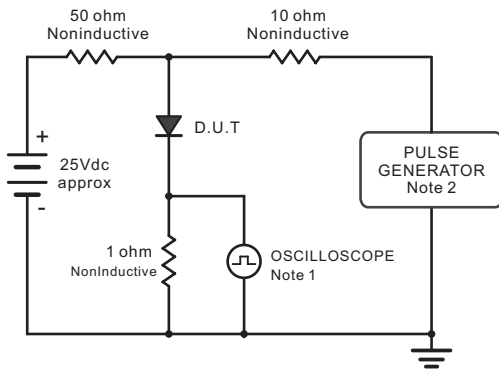

Note: 1. Rise Time = 7ns, max.
Input Impedance = 1megohm, 22pF.
2. Rise Time = 10ns, max.
Source Impedance = 50 ohms.

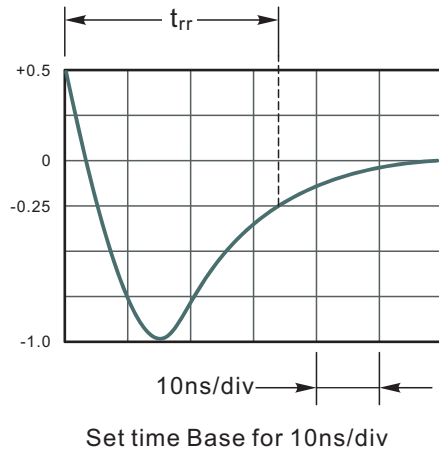

Fig.2 Maximum Average Forward Current Rating

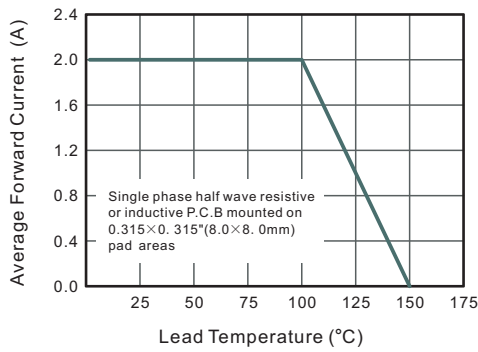

Fig.3 Typical Reverse Characteristics

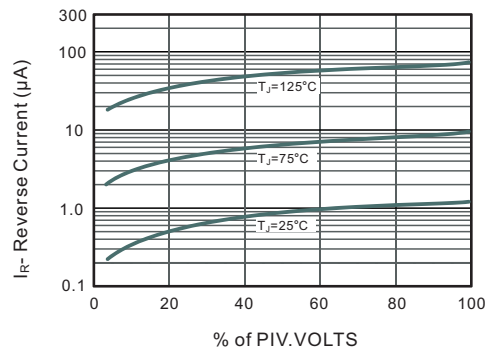

Fig.4 Typical Forward Characteristics

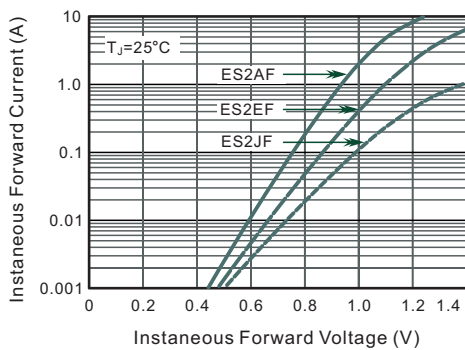
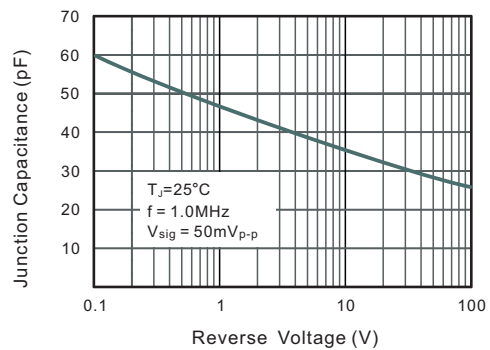
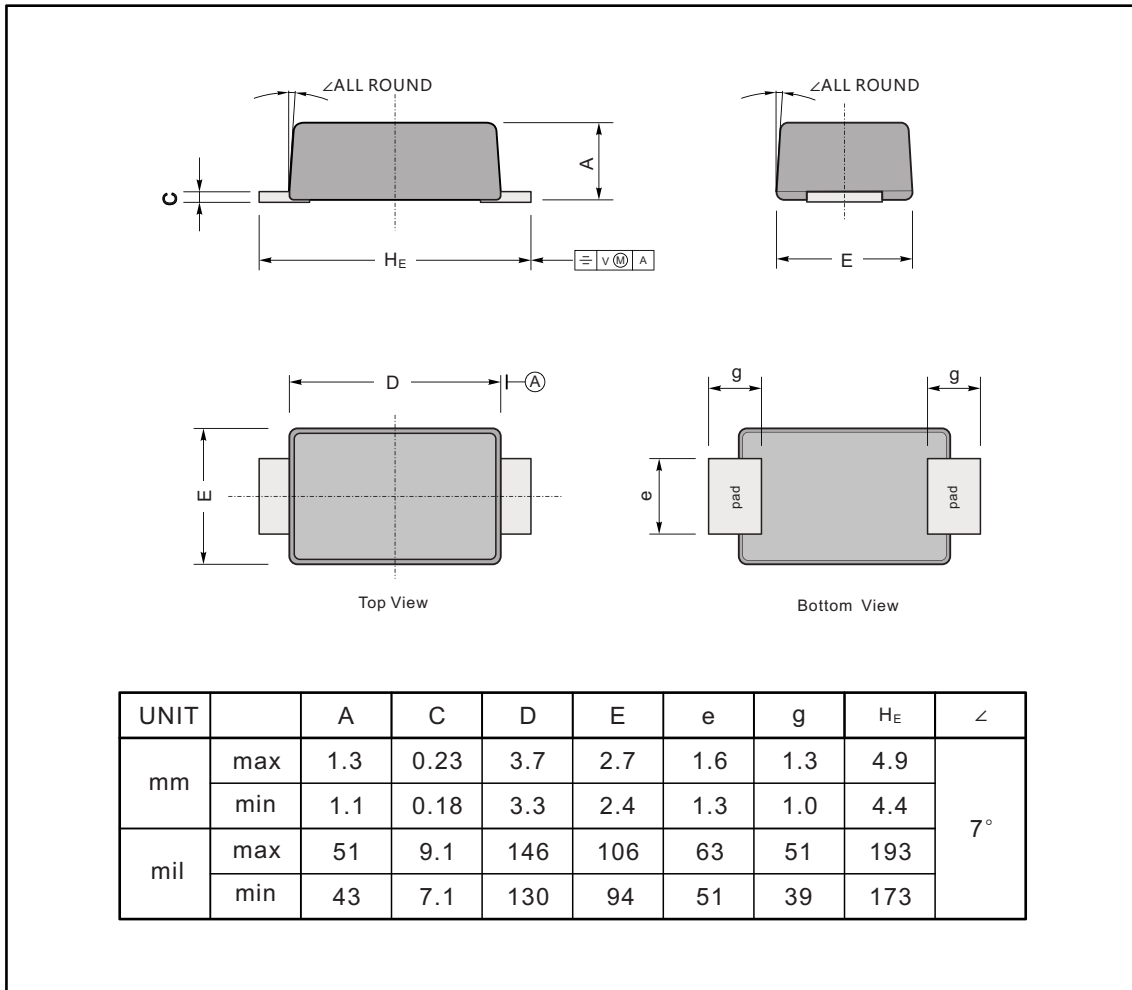
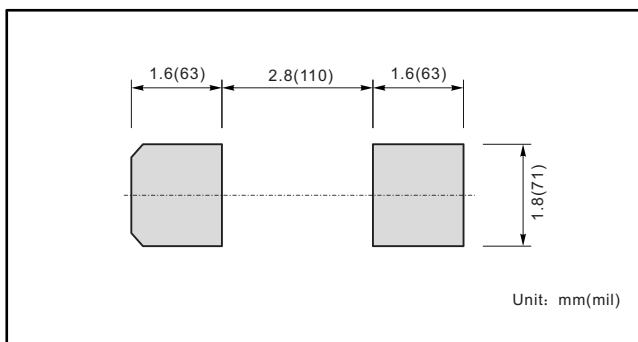

Fig.5 Typical Junction Capacitance



PACKAGE OUTLINE

Plastic surface mounted package; 2 leads

SMAF

The recommended mounting pad size

Marking

Type number	Marking code
ES2AF	ES2A
ES2BF	ES2B
ES2CF	ES2C
ES2DF	ES2D
ES2EF	ES2E
ES2GF	ES2G
ES2JF	ES2J